

RoHS
Compatible

發行
2012.10.18
達立

△				
△				
△				
△				
ZONE	REV	DESCRIPTION	DATE	APPD.

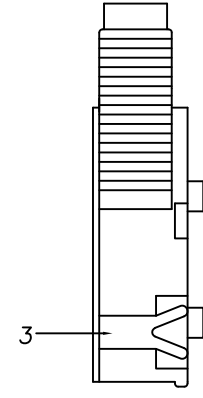
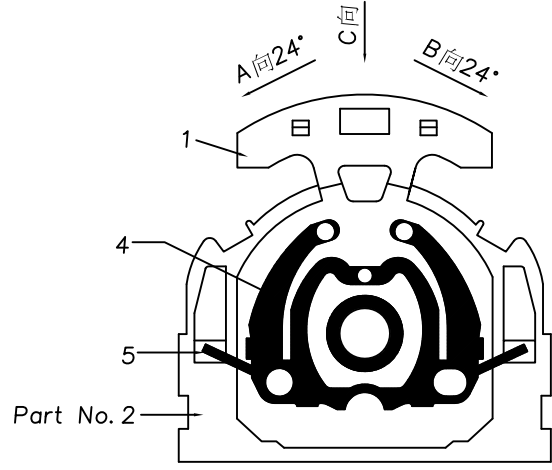
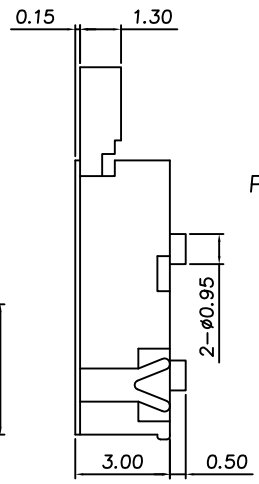
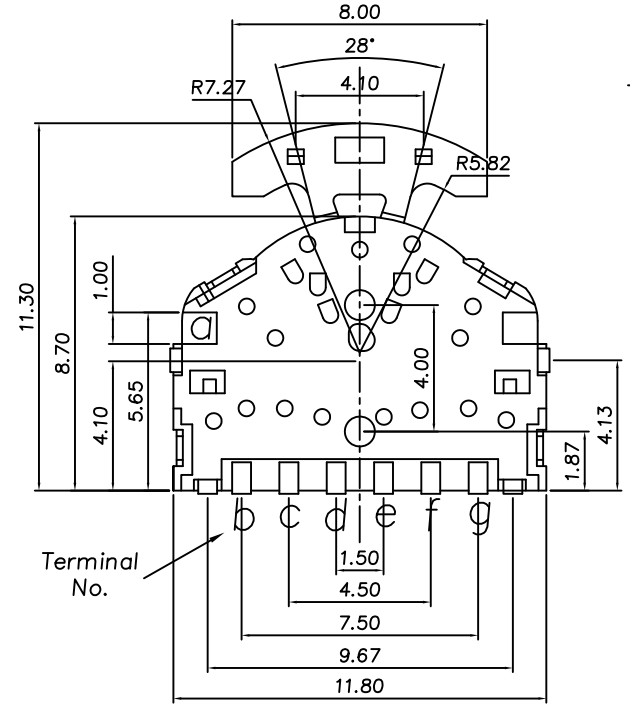

P.C.B Mounting
pattern Dimension

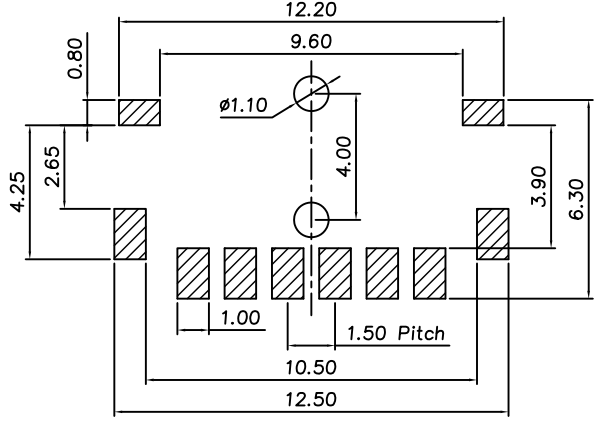

Specification
 Rating : 0.1A DC12V
 Insulation resistance : 100MΩ Min.
 Withstand voltage : AC100C/1 minute
 Operating temperature : -10°C~+60°C
 Operating force : 80±50gf (lever portion)
 205±100gf (push portion)

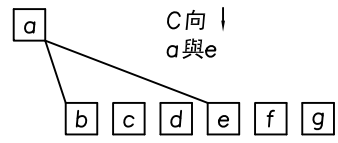
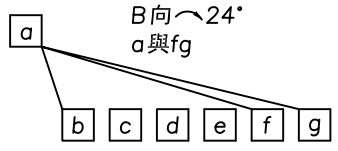
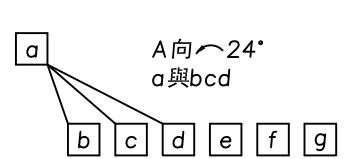

5	Spring	Stainless Steel	1	Natural
4	Contact	Phosphor Bronze	1	Ag Clad
3	Cover	Stainless Steel	1	Natural
2	Case	Nylon	1	Black
1	Stem	Nylon	1	Black
NO	Part Name	Material	Q'ty	Finishing

達立科技股份有限公司
Dawning Precision Co., Ltd.
 TEL: 886-2-82271388 FAX: 886-2-82272198

DESIGN	Benson	SCALE		
DRAWING	Benson	UNIT	mm	
CHECK	Benson	SIZE	A4: 210*297	
APPROVAL	Eric	VERSION	01	

TOLERANCE UNLESS OTHERWISE STATED(mm)	PART NAME	PUSH & LEVER SWITCH
less than 10 — ±0.2	PART NO	K01A-S085
10~30 — ±0.3	DRAWING NO	
30~100 — ±0.5	DATE	2012/10/18
ANGLE — ±2°		