

RoHS
Compatible

△				
△				
△				
△				
ZONE	REV	DESCRIPTION	DATE	APPD.

發行
2009.06.24
達立

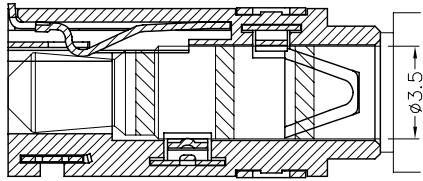

SECTION A-A

MODEL NO.	PJ-3896D	PJ-3895AD	PJ-3895BD	PJ-3894D
SCHEMATIC				

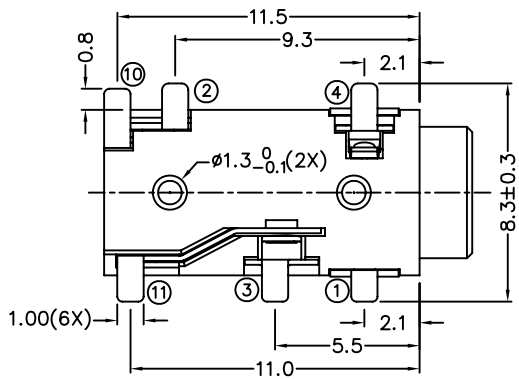
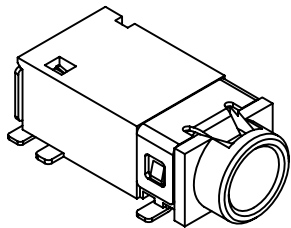
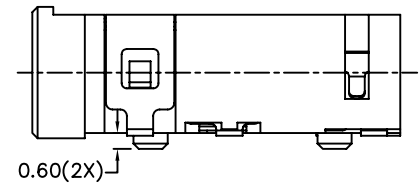
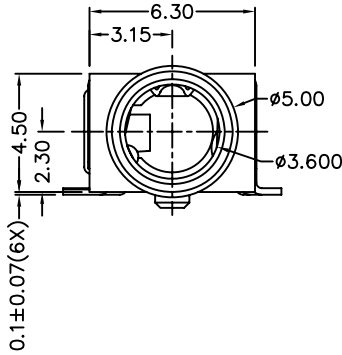
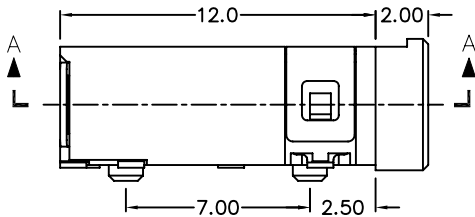
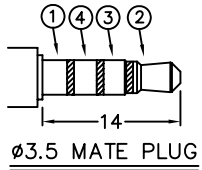

- * MATERIAL
- TERMINAL 1 : COPPER ALLOY
 - TERMINAL 2 : COPPER ALLOY
 - TERMINAL 3 : COPPER ALLOY
 - TERMINAL 4 : COPPER ALLOY
 - TERMINAL 10 : BRASS
 - TERMINAL 11 : BRASS
 - HOUSING : PA6T

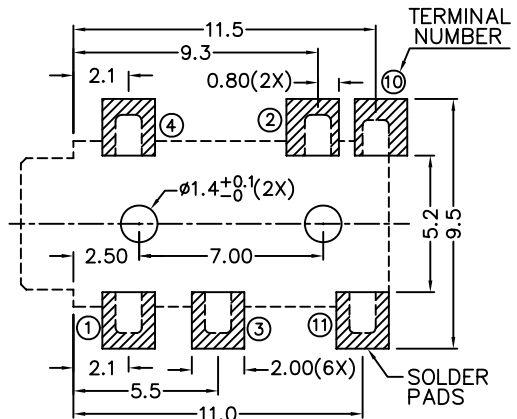

RECOMMENDED SOLDER PAD LAYOUT

達立科技股份有限公司

Dawning Precision Co., Ltd.

TEL: 886-2-82271388 FAX: 886-2-82272198

DESIGN	Will	SCALE		
DRAWING	Will	UNIT	mm	
CHECK	Will	SIZE	A4: 210*297	
APPROVAL	Eric	VERSION	01	

TOLERANCE UNLESS OTHERWISE STATED(mm)
less than 10 — ±0.2
10~30 — ±0.3
30~100 — ±0.5
ANGLE — ±2°

PART NAME	PHONE JACK
PART NO	PJ-389D SERIES
DRAWING NO	
DATE	2009/06/24