

RoHS
Compatible

▲				
▲				
▲				
▲				
ZONE	REV	DESCRIPTION	DATE	APPD.

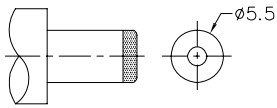
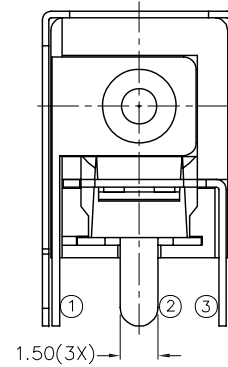
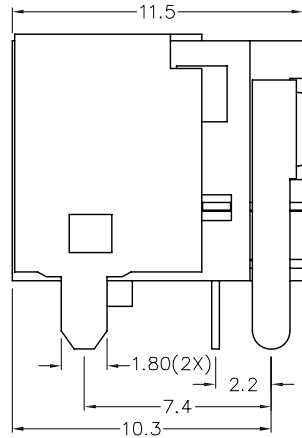
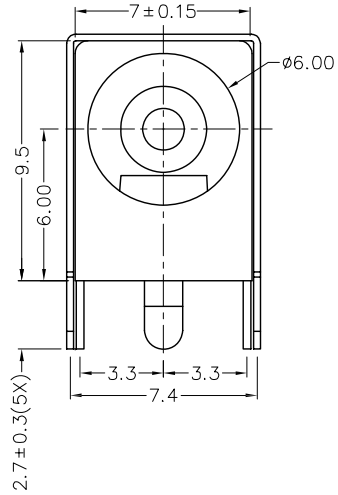
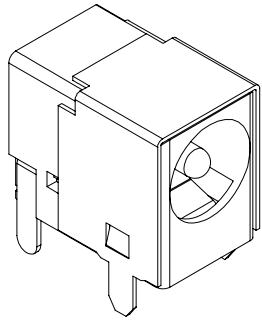

DC MATE PLUG

MODEL NO.	DC-038S
SCHEMATIC	
CENTER PIN	Ø1.65mm
	Ø2mm
	Ø2.5mm

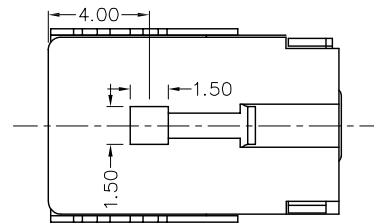

* MATERIAL

CENTRE PIN : COPPER
 TERMINAL 1 : BRASS
 TERMINAL 2 : COPPER ALLOY
 TERMINAL 3 : BRASS
 SHIELD : BRASS
 HOUSING : PBT

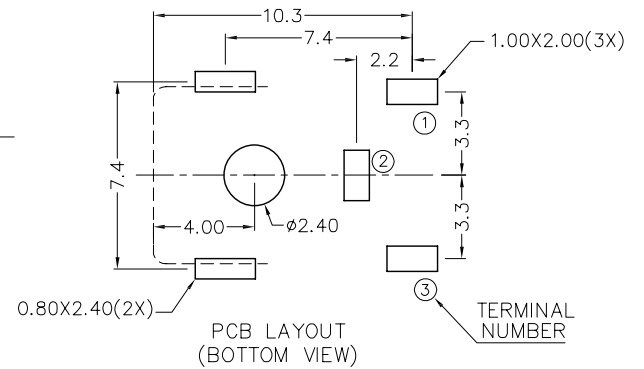

達立科技股份有限公司

Dawning Precision Co., Ltd.

TEL: 886-2-82271388 FAX: 886-2-82272198

DESIGN	Will	SCALE			TOLERANCE UNLESS OTHERWISE STATED(mm)	PART NAME	DC POWER SOCKET
DRAWING	Will	UNIT	mm		less than 10	PART NO	DC-038S
CHECK	Will	SIZE	A4: 210*297		10~30	DRAWING NO	
APPROVAL	Eric	VERSION	01		30~100	DATE	2009/06/09
					ANGIE		

www.dawning2.com.tw