

RoHS
Compatible

▲				
▲				
▲				
▲				
ZONE	REV	DESCRIPTION	DATE	APPD.

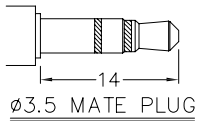
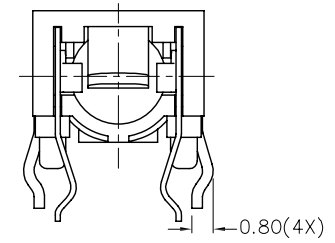
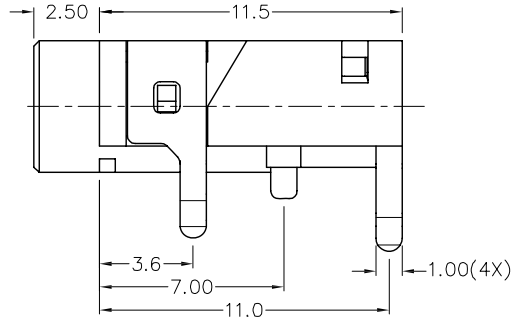
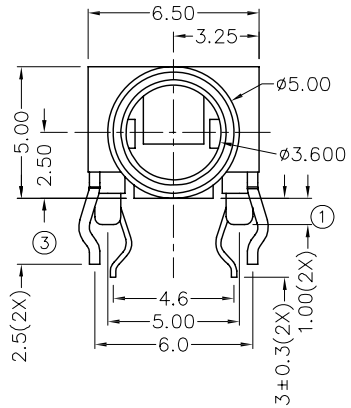
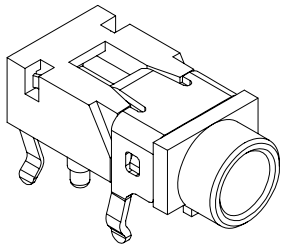

*** MATERIAL**

TERMINAL 1 : COPPER ALLOY
 TERMINAL 2 : COPPER ALLOY
 TERMINAL 3 : COPPER ALLOY
 HOUSING : PA66

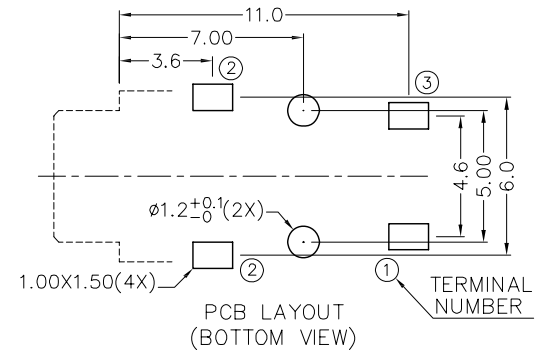
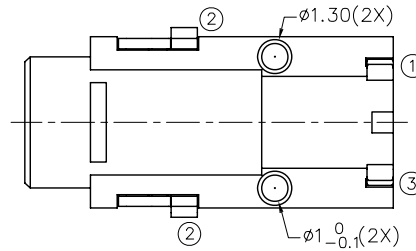
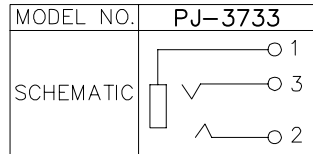

達立科技股份有限公司

Dawning Precision Co., Ltd.

TEL: 886-2-82271388 FAX: 886-2-82272198

DESIGN	Will	SCALE		
DRAWING	Will	UNIT	mm	
CHECK	Will	SIZE	A4: 210*297	
APPROVAL	Eric	VERSION	01	

TOLERANCE UNLESS OTHERWISE STATED(mm)
less than 10 — ±0.2
10~30 — ±0.3
30~100 — ±0.5
ANGIE — ±2°

PART NAME	PHONE JACK
PART NO	PJ-373 SERIES
DRAWING NO	
DATE	2009/11/24