

△				
△				
△				
△				
ZONE	REV	DESCRIPTION	DATE	APPD.

RoHS
Compatible

發行
2012.11.30
達立

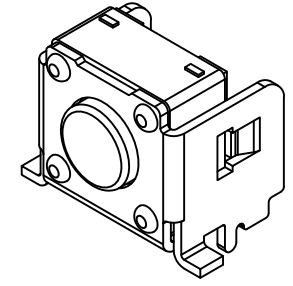
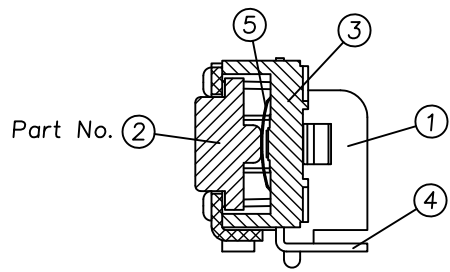

P.C.B Mounting
Pattern Dimension

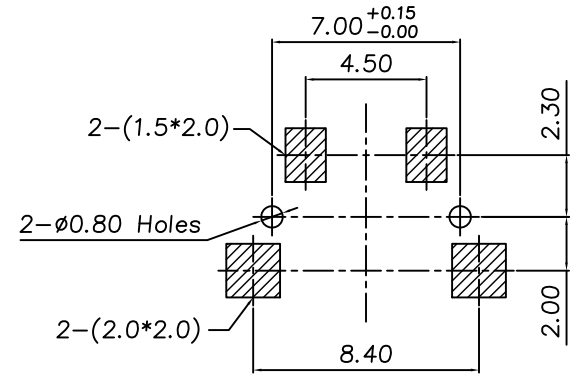

Order Information:
TS-A06_ _ _S016
Force
Stem Size

Stem Size

Model No.	H(mm)	∅D(mm)
TS-A06	3.6	3.5
TS-A06A	4.3	3.5
TS-A06B	6.3	3.0
TS-A06C	8.8	3.0

Circuit diagram

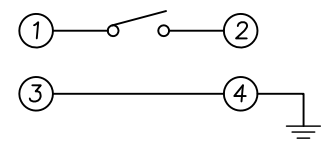

Specification

- Rating : 50mA, DC12V Max.
- Contact resistance : 100mΩ Max.
- Insulation resistance : 100MΩ Min.
- Travel : 0.25^{+0.20}_{-0.10}

Model	Operating Force	Life Cycles	Stem Color
TS-A06_	100±50gf	1,000,000 cycle	Blue
TS-A06_-2	160±50gf	1,000,000 cycle	Black
TS-A06_-3	260±50gf	200,000 cycle	Nature Color

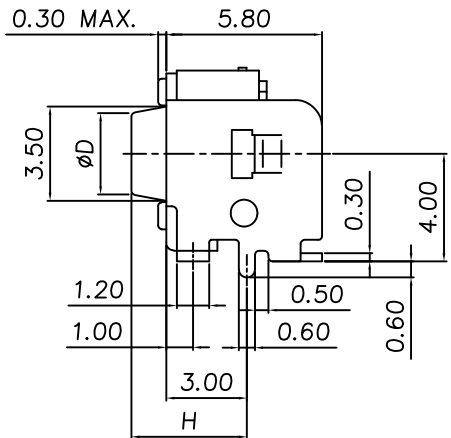
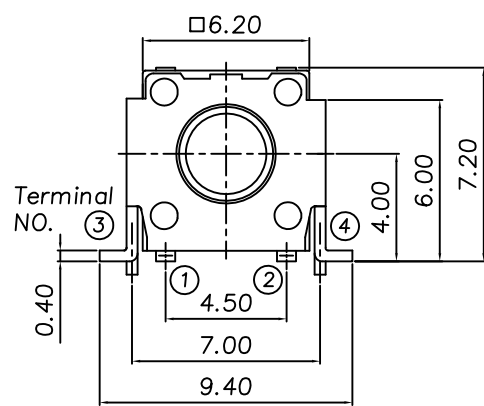
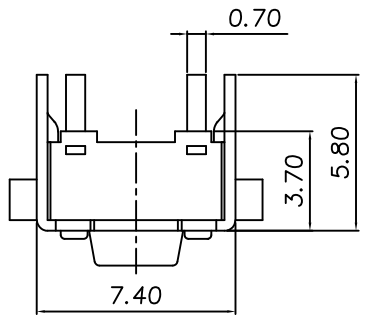

NO	Part Name	Material	Q"ty	Finishing
5	Contact	Stainless Steel	1	Ag Plated
4	Terminal	Copper Alloy	2	Ag Plated
3	Frame	LCP	1	Black
2	Stem	LCP	1	_____
1	Bracket	SPTe	1	Sn Plated

達立科技股份有限公司
Dawning Precision Co., Ltd.
TEL: 886-2-82271388 FAX: 886-2-82272198

DESIGN	Benson	SCALE	
DRAWING	Benson	UNIT	mm
CHECK	Benson	SIZE	A4: 210*297
APPROVAL	Eric	VERSION	01

TOLERANCE UNLESS OTHERWISE STATED(mm)	PART NAME	TACT SWITCH
less than 10 — ±0.2	PART NO	TS-A06-S016 SERIES
10~30 — ±0.3	DRAWING NO	
30~100 — ±0.5	DATE	2012/07/19
ANGIE — ±2°		