

RoHS
Compatible

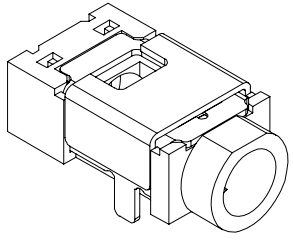

△				
△				
△				
△				
ZONE	REV	DESCRIPTION	DATE	APPD.

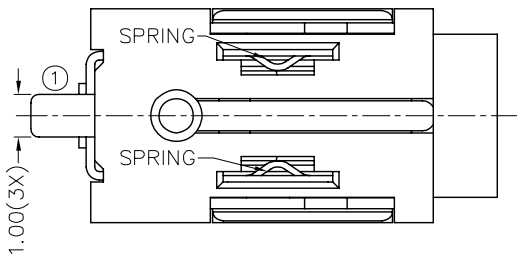
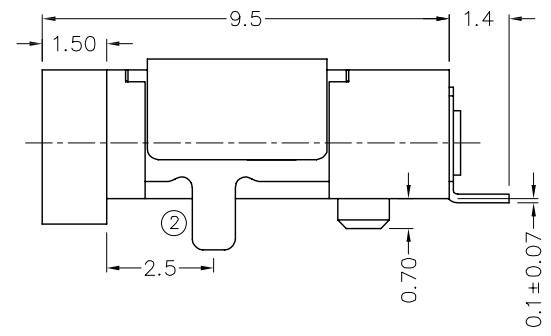
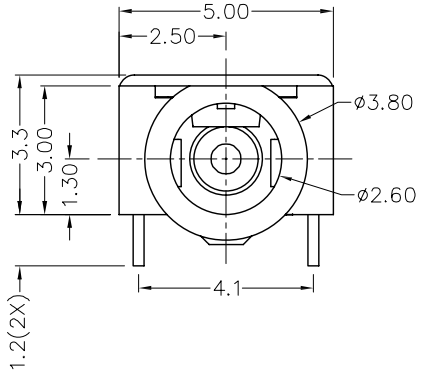
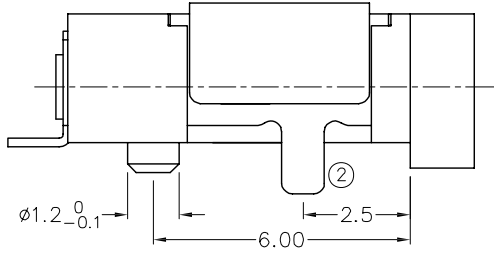

*** MATERIAL**

- CENTRE PIN : COPPER
- TERMINAL 1 : BRASS
- TERMINAL 2 : COPPER ALLOY
- SPRING : STAINLESS STEEL
- SHIELD : BRASS
- HOUSING : PA6T

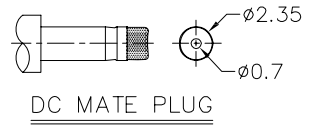
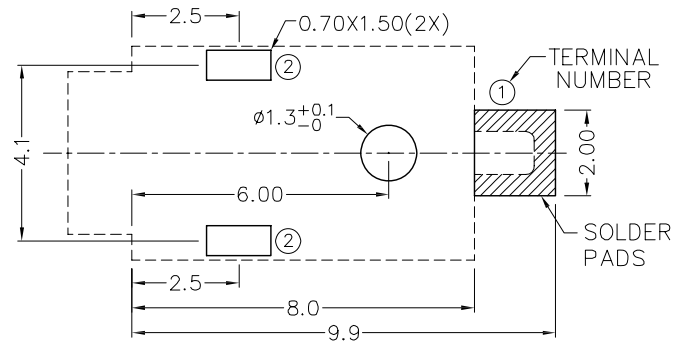

MODEL NO.	DC-063DS-3
SCHEMATIC	1 2
CENTER PIN	$\phi 0.65\text{mm}$

達立科技股份有限公司
Dawning Precision Co., Ltd.
TEL: 886-2-82271388 FAX: 886-2-82272198

DESIGN	Will	SCALE		
DRAWING	Will	UNIT	mm	
CHECK	Will	SIZE	A4: 210*297	
APPROVAL	Eric	VERSION	01	

TOLERANCE UNLESS OTHERWISE STATED(mm)	PART NAME	DC POWER SOCKET
less than 10 ± 0.2	PART NO	DC-063DS-3
10~30 ± 0.3	DRAWING NO	
30~100 ± 0.5	DATE	2009/06/08
ANGIE $\pm 2'$		