

**RoHS**  
**Compatible**

△				
△				
△				
△				
ZONE	REV	DESCRIPTION	DATE	APPD.

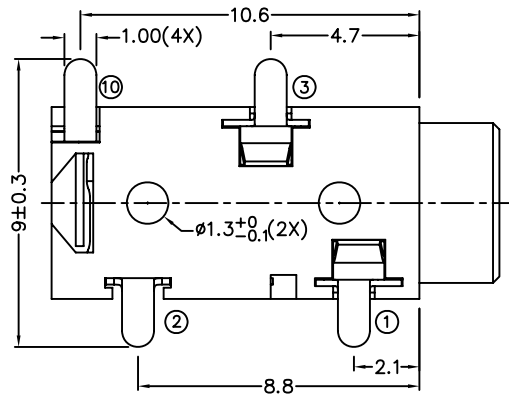

**\* MATERIAL**  
 TERMINAL 1 : COPPER ALLOY  
 TERMINAL 2 : COPPER ALLOY  
 TERMINAL 3 : COPPER ALLOY  
 TERMINAL 10: BRASS  
 HOUSING : PA6T

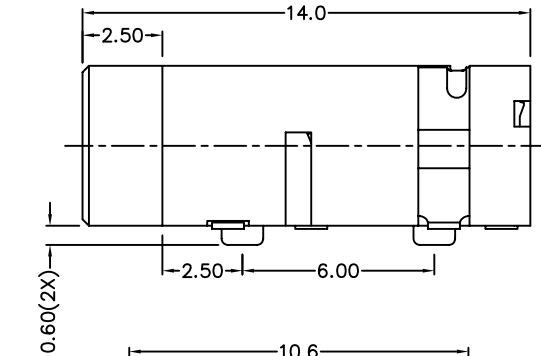
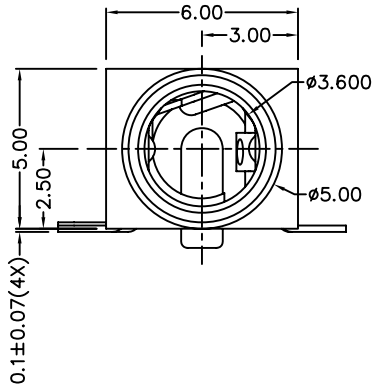
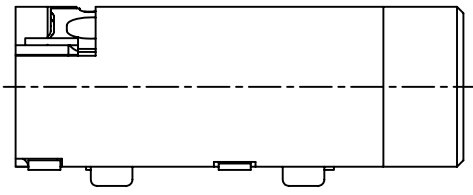
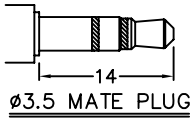
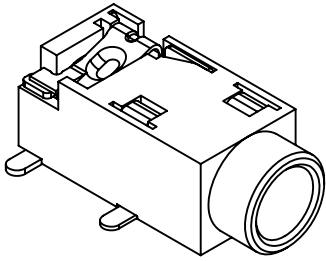
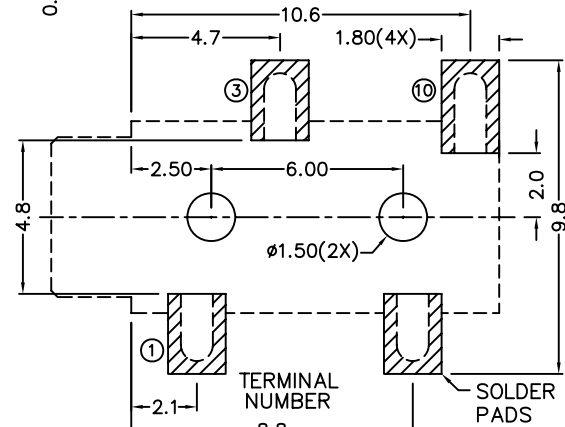

RECOMMENDED  
SOLDER PAD LAYOUT

MODEL NO.	PJ-3814D	PJ-3813D	PJ-3813AD
SCHEMATIC			

**達立科技股份有限公司**

**Dawning Precision Co., Ltd.**

TEL: 886-2-82271388 FAX: 886-2-82272198

DESIGN	Will	SCALE		
DRAWING	Will	UNIT	mm	
CHECK	Will	SIZE	A4: 210*297	
APPROVAL	Eric	VERSION	01	

TOLERANCE UNLESS OTHERWISE STATED(mm)
less than 10 — ±0.2
10~30 — ±0.3
30~100 — ±0.5
ANGIE — ±2°

PART NAME	PHONE JACK
PART NO	PJ-381D SERIES
DRAWING NO	
DATE	2009/11/25

www.dawning2.com.tw