

RoHS
Compatible

▲				
▲				
▲				
▲				
ZONE	REV	DESCRIPTION	DATE	APPD.

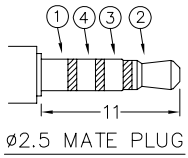
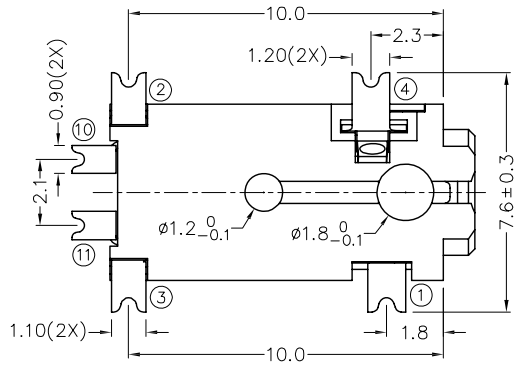
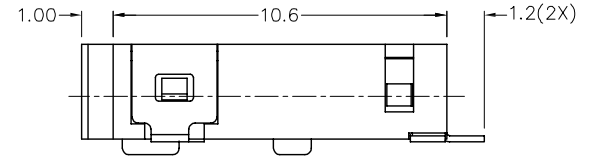
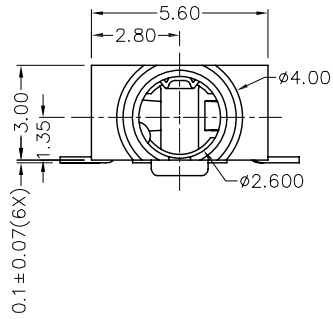
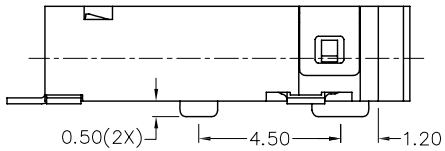
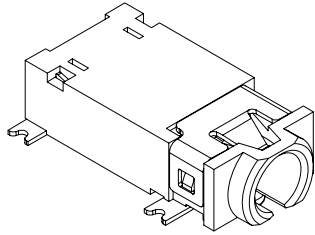

*** MATERIAL**

- TERMINAL 1 : COPPER ALLOY
- TERMINAL 2 : BERYLLIUM COPPER
- TERMINAL 3 : BERYLLIUM COPPER
- TERMINAL 4 : COPPER ALLOY
- TERMINAL 10 : COPPER ALLOY
- TERMINAL 11 : COPPER ALLOY
- HOUSING : PA6T

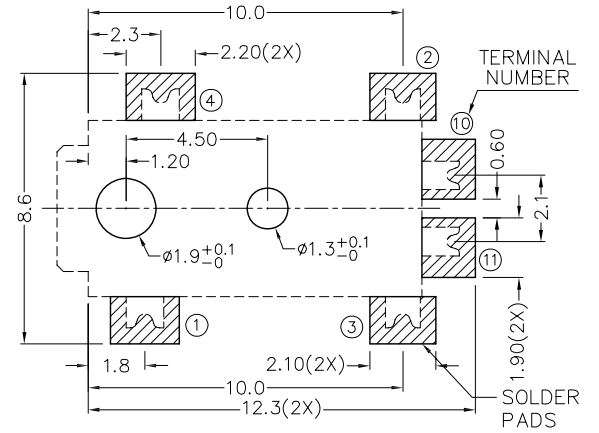

RECOMMENDED
SOLDER PAD LAYOUT

MODEL NO.	PJ-4006D	PJ-4005AD	PJ-4005BD	PJ-4004D
SCHEMATIC				

達立科技股份有限公司

Dawning Precision Co., Ltd.

TEL: 886-2-82271388 FAX: 886-2-82272198

DESIGN	Will	SCALE		
DRAWING	Will	UNIT	mm	
CHECK	Will	SIZE	A4: 210*297	
APPROVAL	Eric	VERSION	01	

TOLERANCE UNLESS OTHERWISE STATED(mm)
less than 10 — ±0.2
10~30 — ±0.3
30~100 — ±0.5
ANGIE — ±2°

PART NAME	PHONE JACK
PART NO	PJ-400D SERIES
DRAWING NO	
DATE	2009/12/01