

**RoHS**  
**Compatible**

|      |     |             |      |       |
|------|-----|-------------|------|-------|
| ▲    |     |             |      |       |
| ▲    |     |             |      |       |
| ▲    |     |             |      |       |
| ▲    |     |             |      |       |
| ZONE | REV | DESCRIPTION | DATE | APPD. |

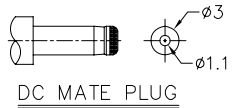
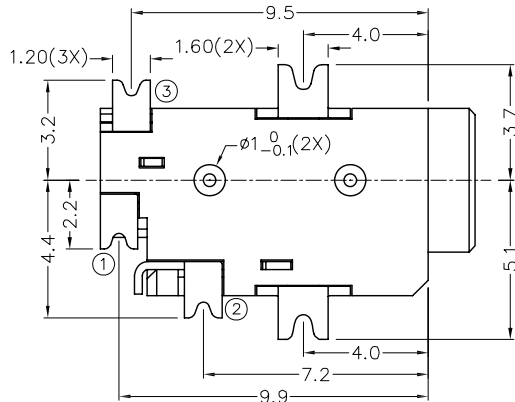
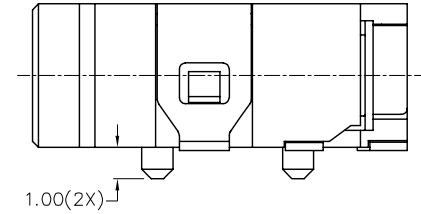
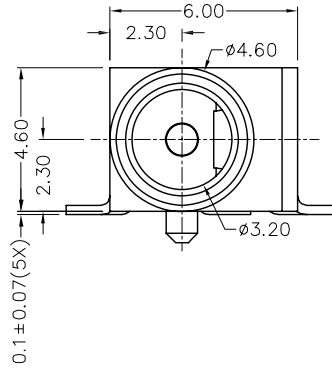
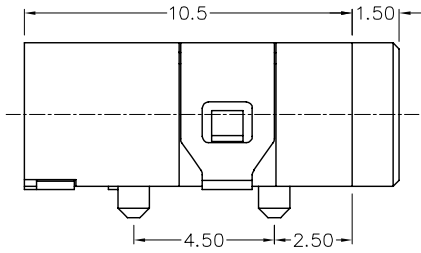
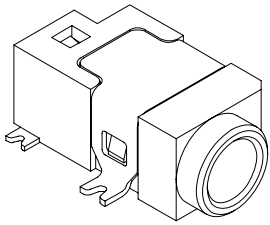

|            |             |
|------------|-------------|
| MODEL NO.  | DC-067DS    |
| SCHEMATIC  | 1<br>3<br>2 |
| CENTER PIN | φ1mm        |

**\* MATERIAL**

- TERMINAL 1 : BRASS
- TERMINAL 2 : COPPER ALLOY
- TERMINAL 3 : BRASS
- SHIELD : C.R. STEEL
- HOUSING : PA6T

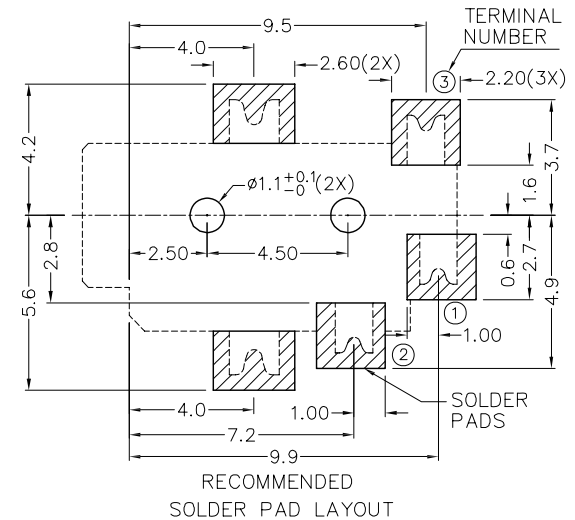

**達立科技股份有限公司**

**Dawning Precision Co., Ltd.**

TEL: 886-2-82271388 FAX: 886-2-82272198

|          |      |         |             |  |
|----------|------|---------|-------------|--|
| DESIGN   | Will | SCALE   |             |  |
| DRAWING  | Will | UNIT    | mm          |  |
| CHECK    | Will | SIZE    | A4: 210*297 |  |
| APPROVAL | Eric | VERSION | 01          |  |

|                                       |      |
|---------------------------------------|------|
| TOLERANCE UNLESS OTHERWISE STATED(mm) |      |
| less than 10                          | ±0.2 |
| 10~30                                 | ±0.3 |
| 30~100                                | ±0.5 |
| ANGIE                                 | ±2°  |

|            |                 |
|------------|-----------------|
| PART NAME  | DC POWER SOCKET |
| PART NO    | DC-067DS        |
| DRAWING NO |                 |
| DATE       | 2009/06/08      |