

RoHS
Compatible

△				
△				
△				
△				
ZONE	REV	DESCRIPTION	DATE	APPD.

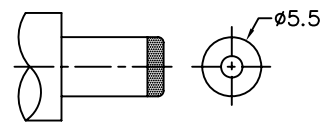

DC MATE PLUG

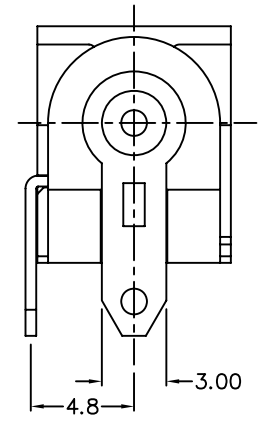
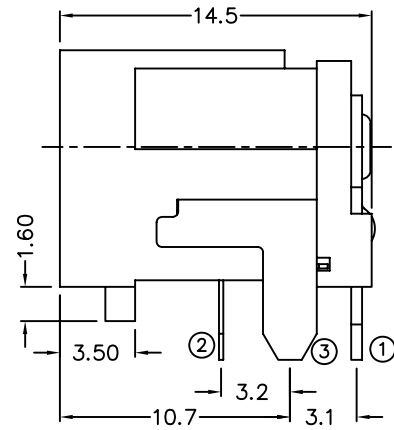
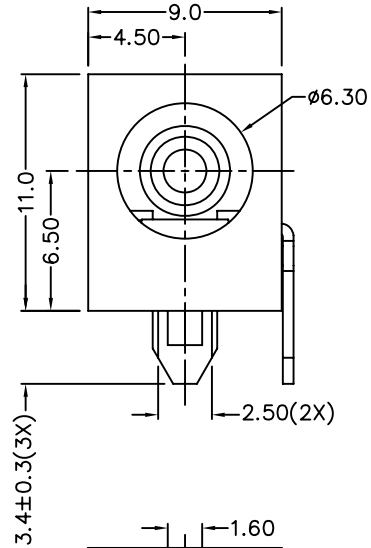
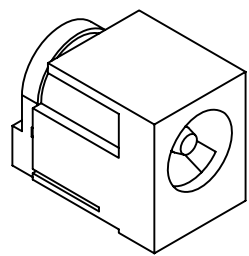
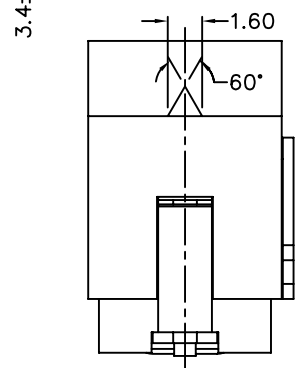

*** MATERIAL**

- CENTRE PIN : COPPER
- TERMINAL 1 : BRASS
- TERMINAL 2 : COPPER ALLOY
- TERMINAL 3 : BRASS
- HOUSING : PBT
- COVER : PBT

MODEL NO.	DC-061
SCHEMATIC	
CENTER PIN	φ2mm φ2.5mm

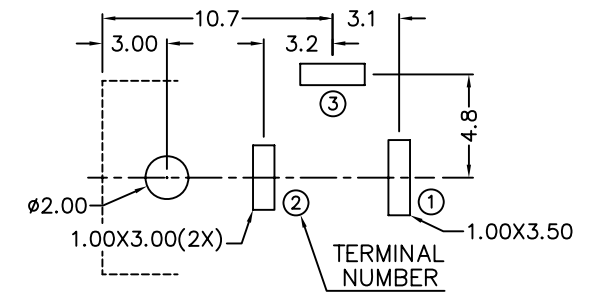

PCB LAYOUT
(BOTTOM VIEW)

達立科技股份有限公司
Dawning Precision Co., Ltd.
TEL: 886-2-82271388 FAX: 886-2-82272198

DESIGN	Will	SCALE		
DRAWING	Will	UNIT	mm	
CHECK	Will	SIZE	A4: 210*297	
APPROVAL	Eric	VERSION	01	

TOLERANCE UNLESS OTHERWISE STATED(mm)
less than 10 — ±0.2
10~30 — ±0.3
30~100 — ±0.5
ANGIE — ±2°

PART NAME	DC POWER SOCKET
PART NO	DC-061
DRAWING NO	
DATE	2009/06/10