

RoHS
Compatible

▲				
▲				
▲				
▲				
ZONE	REV	DESCRIPTION	DATE	APPD.

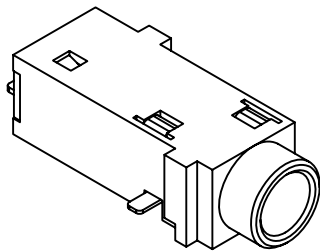

FOR EXTRA SLIM APPLICATION

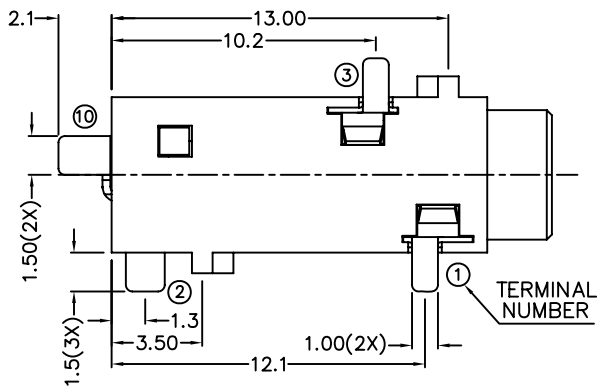
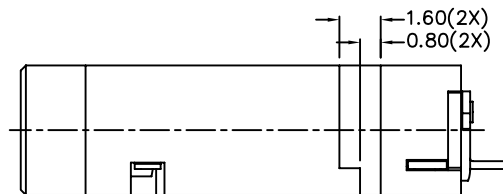
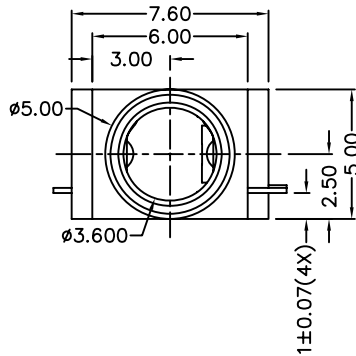
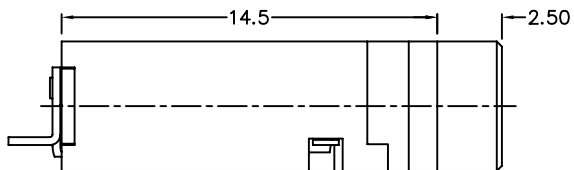

*** MATERIAL**

- TERMINAL 1 : COPPER ALLOY
- TERMINAL 2 : COPPER ALLOY
- TERMINAL 3 : COPPER ALLOY
- TERMINAL 10: BRASS
- HOUSING : PA6T
- COVER : PA6T

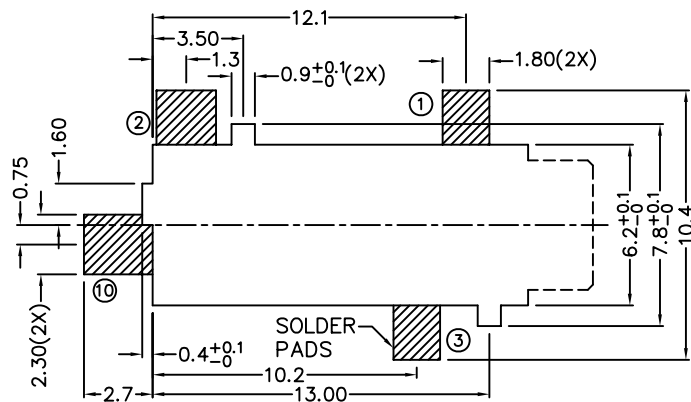

RECOMMENDED
SOLDER PAD LAYOUT

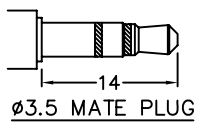

MODEL NO.	PJ-3804D	PJ-3803D	PJ-3803AD
SCHEMATIC			

達立科技股份有限公司

Dawning Precision Co., Ltd.

TEL: 886-2-82271388 FAX: 886-2-82272198

DESIGN	Will	SCALE		
DRAWING	Will	UNIT	mm	
CHECK	Will	SIZE	A4: 210*297	
APPROVAL	Eric	VERSION	01	

TOLERANCE UNLESS OTHERWISE STATED(mm)	PART NAME	PHONE JACK
less than 10 — ±0.2	PART NO	PJ-380D SERIES
10~30 — ±0.3	DRAWING NO	
30~100 — ±0.5	DATE	2009/11/25
ANGIE — ±2°		