

RoHS
Compatible

發行
2009.06.25
達立

△				
△				
△				
△				
ZONE	REV	DESCRIPTION	DATE	APPD.

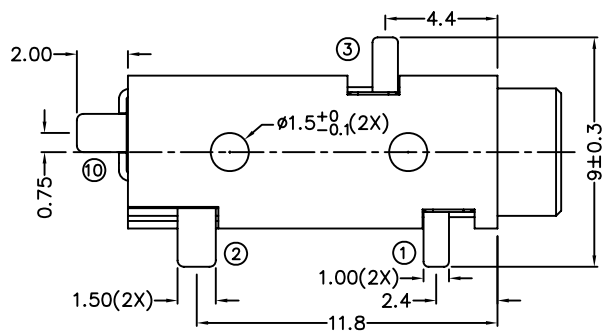
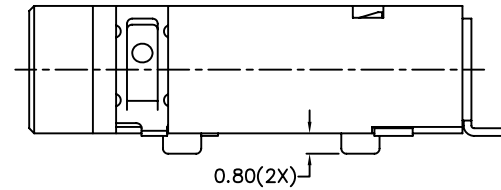
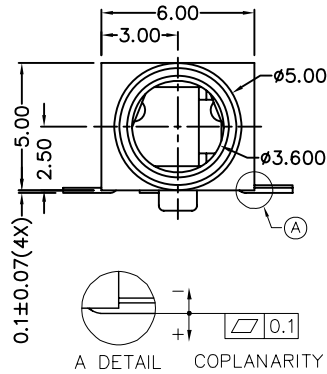
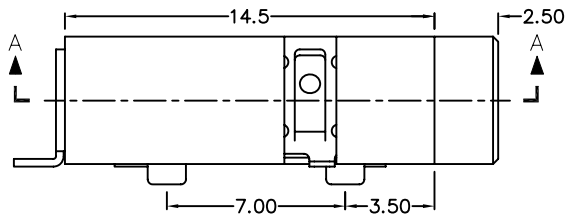
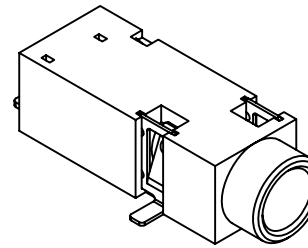
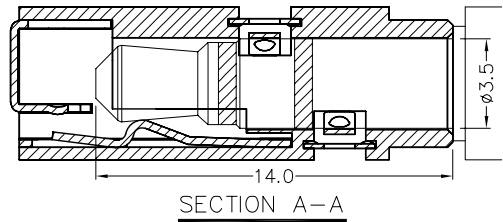

*** MATERIAL**

TERMINAL 1 : COPPER ALLOY
TERMINAL 2 : COPPER ALLOY
TERMINAL 3 : COPPER ALLOY
TERMINAL 10 : BRASS
HOUSING : PA6T

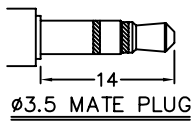
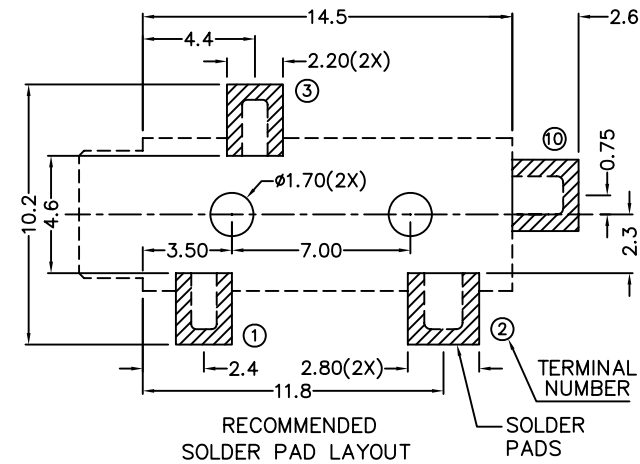

MODEL NO.	PJ-3874D	PJ-3873D	PJ-3873AD
SCHMATIC			

達立科技股份有限公司

Dawning Precision Co., Ltd.

TEL: 886-2-82271388 FAX: 886-2-82272198

DESIGN	Will	SCALE		
DRAWING	Will	UNIT	mm	
CHECK	Will	SIZE	A4: 210*297	
APPROVAL	Eric	VERSION	01	

TOLERANCE UNLESS OTHERWISE STATED(mm)
less than 10 — ±0.2
10~30 — ±0.3
30~100 — ±0.5
ANGIE — ±2°

PART NAME	PHONE JACK
PART NO	PJ-387D SERIES
DRAWING NO	
DATE	2009/06/25

www.dawning2.com.tw