

RoHS
Compatible

▲				
▲				
▲				
▲				
ZONE	REV	DESCRIPTION	DATE	APPD.

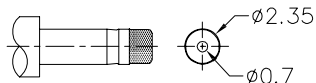
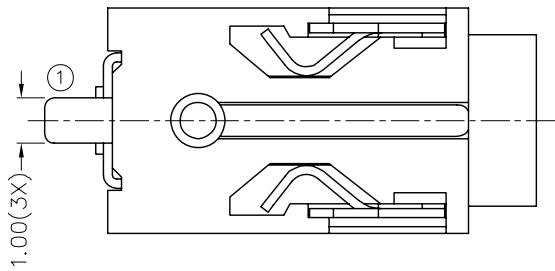
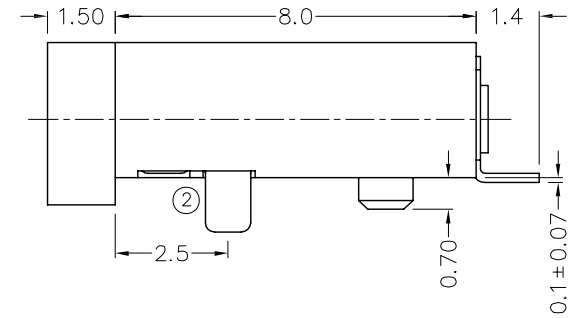
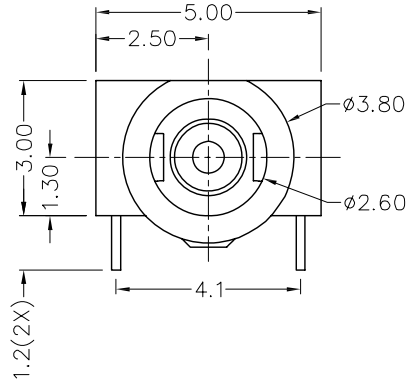
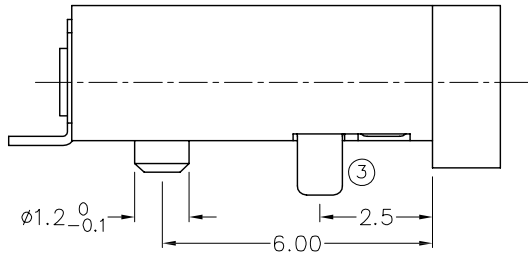
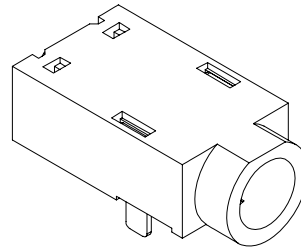

DC MATE PLUG

* MATERIAL

CENTRE PIN : COPPER
 TERMINAL 1 : BRASS
 TERMINAL 2 : COPPER ALLOY
 TERMINAL 3 : COPPER ALLOY
 HOUSING : PA6T

MODEL NO.	DC-064D-3
SCHEMATIC	
CENTER PIN	$\phi 0.65\text{mm}$

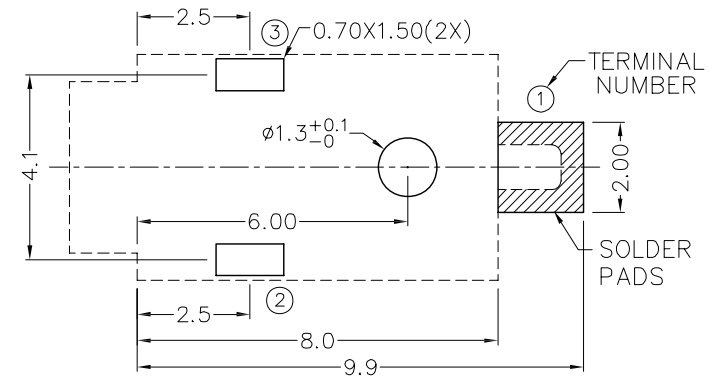

RECOMMENDED
SOLDER PAD LAYOUT

達立科技股份有限公司

Dawning Precision Co., Ltd.

TEL: 886-2-82271388 FAX: 886-2-82272198

DESIGN	Will	SCALE		
DRAWING	Will	UNIT	mm	
CHECK	Will	SIZE	A4: 210*297	
APPROVAL	Eric	VERSION	01	

TOLERANCE UNLESS OTHERWISE STATED(mm)	
less than 10	± 0.2
10~30	± 0.3
30~100	± 0.5
ANGIE	$\pm 2'$

PART NAME	DC POWER SOCKET
PART NO	DC-064D-3
DRAWING NO	
DATE	2009/06/08