

▲				
▲				
▲				
▲				
ZONE	REV	DESCRIPTION	DATE	APPD.

RoHS
Compatible

發行
2013.01.16
達立

P.C.B Mounting
pattern Dimension

Circuit diagram

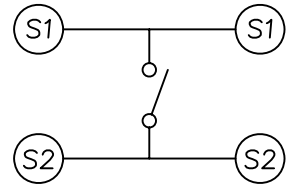
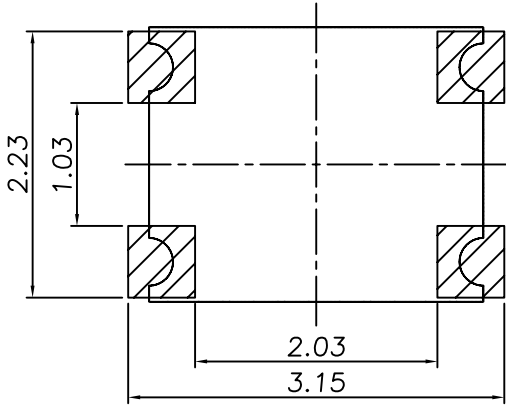

Specification

1. Rating : DC 12V 20mA Max.
2. Contact resistance : 100mΩ Max.
3. Insulation resistance : 100MΩ Min.
4. Travel : 0.15±0.07mm
5. Operating life : 300,000 cycles Min.
6. Operating force: 160±50g

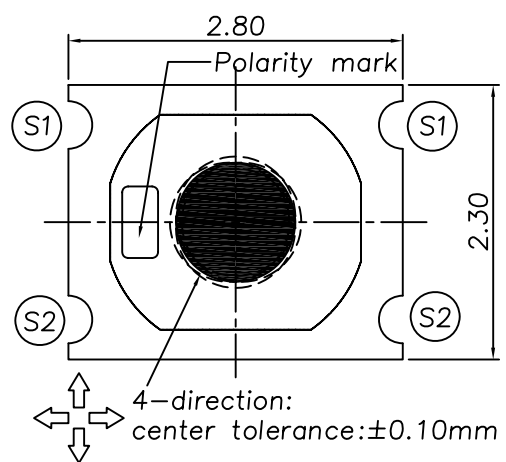

Design recommend :

1. Recommendable keytop shape :
Please refer to the drawing on the right.

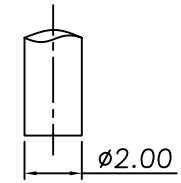

2. Recommendable keytop shape :
Gap between the center of switch operating portion and keytop should be 0.3mm Max.

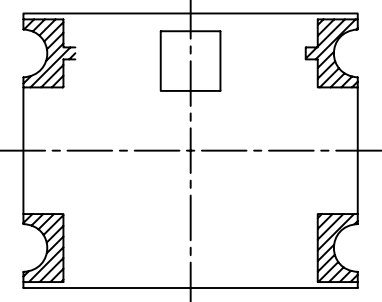
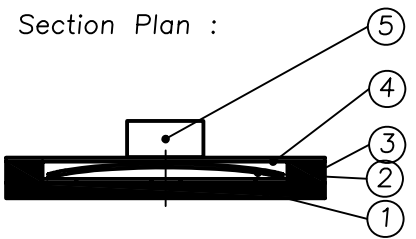
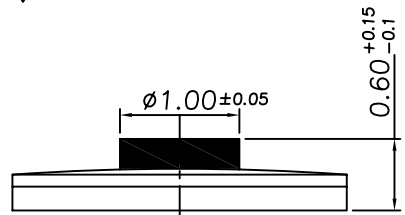
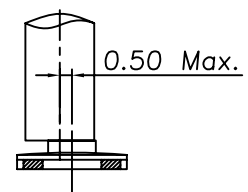

Bottom View

⑤	Actuator	Heat-resistant resin	1	UL 94V-0V(Black)
④	Waterproof Sheet	Anti-Heatpolyimide Strip	1	UL 94V-0V(Natural)
③	Adhesive Sheet	Anti-Heatpolyimide Strip	1	UL 94V-0V(Natural)
②	Tactile Spring	Stainless Steel Strip	1	Ag Plated
①	Circuit	FR-4	1	UL 94V-0V(Natural)
NO	Part Name	Material	Q'ty	Finishing

達立科技股份有限公司
Dawning Precision Co., Ltd.
TEL: 886-2-82271388 FAX: 886-2-82272198

DESIGN	Will	SCALE	
DRAWING	Will	UNIT	mm
CHECK	Will	SIZE	A4: 210*297
APPROVAL	Eric	VERSION	01

TOLERANCE UNLESS OTHERWISE STATED(mm)	PART NAME	TACT SWITCH
less than 10 ±0.2	PART NO	TST70-C-160-T50
10~30 ±0.3	DRAWING NO	
30~100 ±0.5	DATE	2011/03/16
ANGIE ±2°		