

RoHS
Compatible

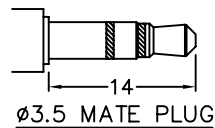

△				
△				
△				
△				
ZONE	REV	DESCRIPTION	DATE	APPD.

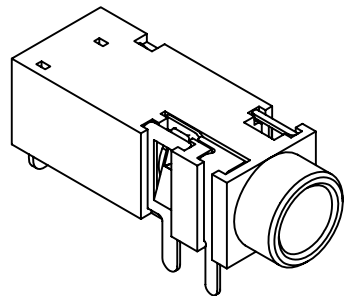
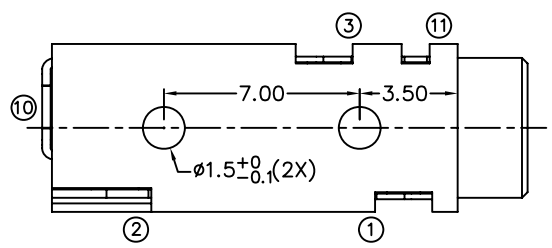
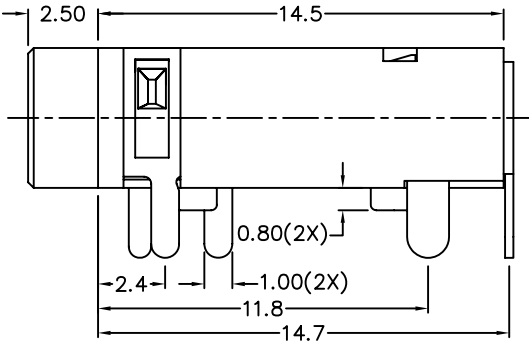
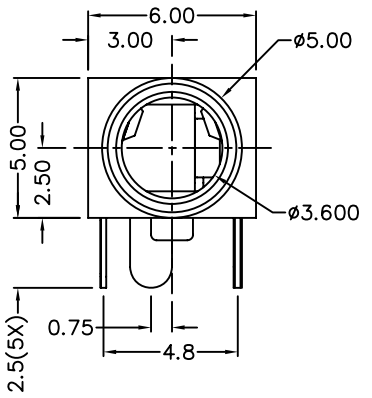
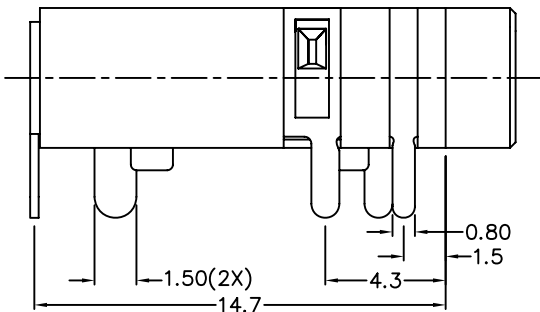

*** MATERIAL**
 TERMINAL 1 : COPPER ALLOY
 TERMINAL 2 : COPPER ALLOY
 TERMINAL 3 : COPPER ALLOY
 TERMINAL 10 : BRASS
 TERMINAL 11 : BRASS
 HOUSING : PA66

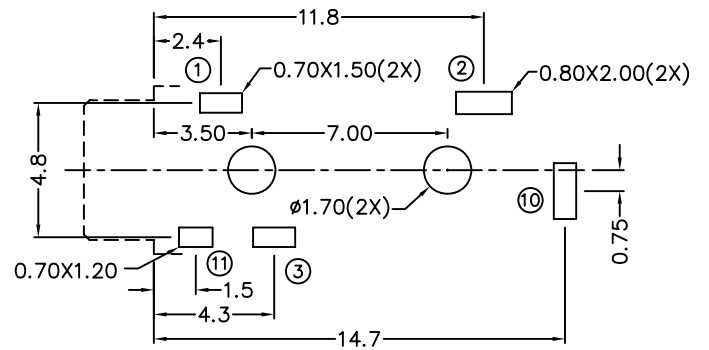

MODEL NO.	PJ-3765	PJ-3764A	PJ-3764B	PJ-3763	PJ-3763A	PJ-3762
SCHEMATIC						

達立科技股份有限公司
Dawning Precision Co., Ltd.
 TEL: 886-2-82271388 FAX: 886-2-82272198

DESIGN	Will	SCALE		
DRAWING	Will	UNIT	mm	
CHECK	Will	SIZE	A4: 210*297	
APPROVAL	Eric	VERSION	01	

TOLERANCE UNLESS OTHERWISE STATED(mm)	PART NAME	PHONE JACK
less than 10 — ±0.2	PART NO	PJ-376 SERIES
10~30 — ±0.3	DRAWING NO	
30~100 — ±0.5	DATE	2009/11/25
ANGIE — ±2°		

www.dawning2.com.tw