

RoHS
Compatible

△				
△				
△				
△				
ZONE	REV	DESCRIPTION	DATE	APPD.

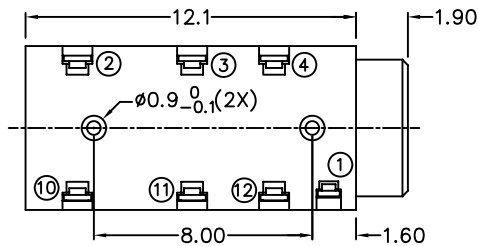
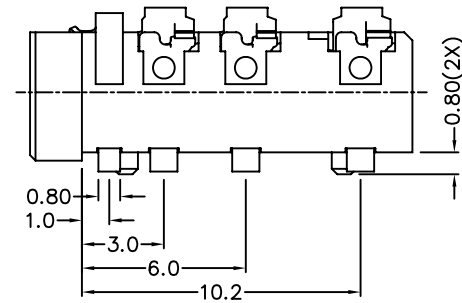
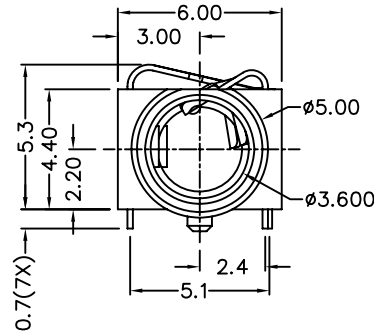
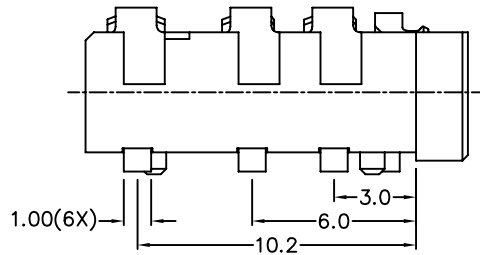
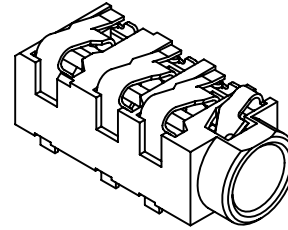

*** MATERIAL**

- TERMINAL 1 : COPPER ALLOY
- TERMINAL 2 : COPPER ALLOY
- TERMINAL 3 : COPPER ALLOY
- TERMINAL 4 : COPPER ALLOY
- TERMINAL 10 : BRASS
- TERMINAL 11 : BRASS
- TERMINAL 12 : BRASS
- HOUSING : PA6T

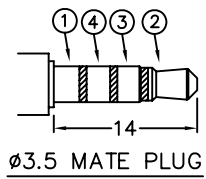
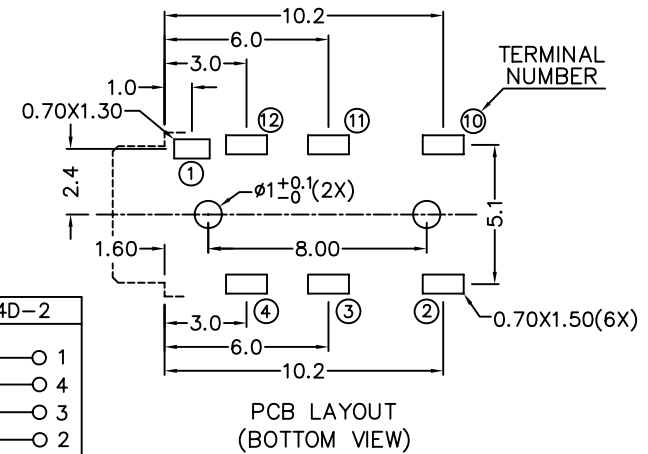

MODEL NO.	PJ-3907D-2	PJ-3906AD-2	PJ-3905AD-2	PJ-3905BD-2	PJ-3904D-2
SCHEMATIC					

達立科技股份有限公司
Dawning Precision Co., Ltd.
TEL: 886-2-82271388 FAX: 886-2-82272198

DESIGN	Will	SCALE		
DRAWING	Will	UNIT	mm	
CHECK	Will	SIZE	A4: 210*297	
APPROVAL	Eric	VERSION	01	

TOLERANCE UNLESS OTHERWISE STATED(mm)
less than 10 — ±0.2
10~30 — ±0.3
30~100 — ±0.5
ANGIE — ±2°

PART NAME	PHONE JACK
PART NO	PJ-390D-2 SERIES
DRAWING NO	
DATE	2009/11/26